

FEATURES

- WIDE SUPPLY RANGE — $\pm 15V$ to $\pm 150V$
- PROGRAMMABLE OUTPUT CURRENT LIMIT
- HIGH OUTPUT CURRENT — Up to $\pm 150mA$
- LOW BIAS CURRENT — FET Input

APPLICATIONS

- HIGH VOLTAGE INSTRUMENTATION
- ELECTROSTATIC TRANSDUCERS & DEFLECTION
- PROGRAMMABLE POWER SUPPLIES UP TO 290V
- ANALOG SIMULATORS

DESCRIPTION

The PA08 is a high voltage operational amplifier designed for output voltage swings of up to $\pm 145V$ with a dual (\pm) supply or 290V with a single supply. High accuracy is achieved with a cascode input circuit configuration. All internal biasing is referenced to a zener diode fed by a FET constant current source. As a result, the PA08 features an unprecedented supply range and excellent supply rejection. The output stage is biased-on for linear operation. Internal phase compensation assures stability at all gain settings. The safe operating area (SOA) can be observed with all types of loads by choosing the appropriate current limiting resistors. For operation into inductive loads, two external flyback pulse protection diodes are recommended. A heatsink may be necessary to maintain the proper case temperature under normal operating conditions.

This hybrid integrated circuit utilizes beryllia (BeO) substrate, thick film resistors, ceramic capacitors and semiconductor chips to maximize reliability, minimize size and give top performance. Ultrasonically bonded aluminum wires provide reliable interconnections at all operating temperatures. The 8-pin TO-3 package is hermetically sealed and electrically isolated. The use of compressible thermal isolation washers and/or improper mounting torque will void the product warranty. Please see "General Operating Considerations".

EQUIVALENT SCHEMATIC

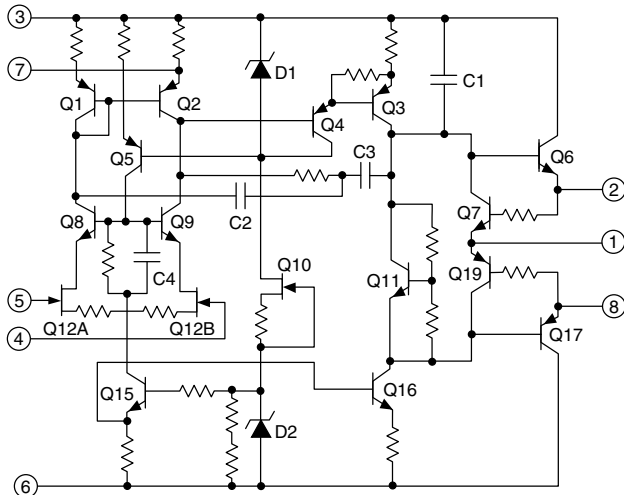

8-PIN TO-3 PACKAGE STYLE CE

TYPICAL APPLICATION

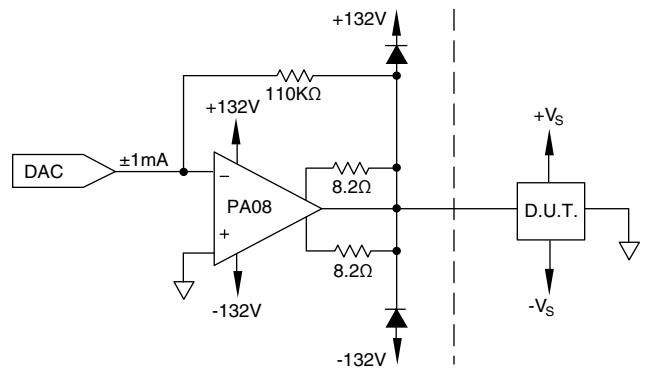

ATE PIN DRIVER

The PA08 as a pin driver is capable of supplying high test voltages to a device under test (DUT). Due to the possibility of short circuits to any terminal of the DUT, current limit must be set to be safe when limiting with a supply to output voltage differential equal to the amplifier supply plus the largest magnitude voltage applied to any other pin of the DUT. In addition, flyback diodes are recommended when the output of the amplifier exits any equipment enclosure to prevent damage due to electrostatic discharges. Refer to Application Note 7 for details on accuracy considerations of this circuit.

EXTERNAL CONNECTIONS

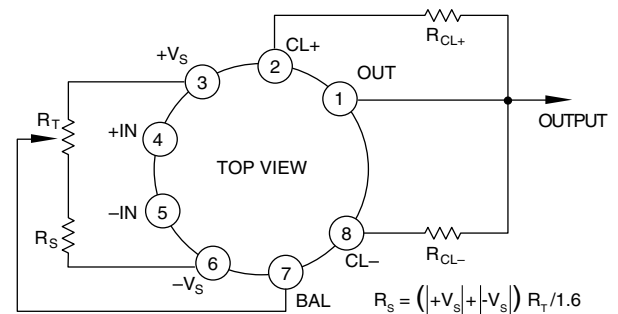

NOTE: Input offset voltage trim optional. $R_T = 10K\Omega$ MAX

PA08 • PA08A

ABSOLUTE MAXIMUM RATINGS SPECIFICATIONS

ABSOLUTE MAXIMUM RATINGS

SUPPLY VOLTAGE, $+V_S$ to $-V_S$	300V
OUTPUT CURRENT, within SOA	200mA
POWER DISSIPATION, internal at $T_C = 25^\circ\text{C}$	17.5W
INPUT VOLTAGE, differential	$\pm 50\text{V}$
INPUT VOLTAGE, common mode	$\pm V_S$
TEMPERATURE, pin solder - 10s max	300°C
TEMPERATURE, junction ¹	175°C
TEMPERATURE RANGE, storage	-65 to $+150^\circ\text{C}$
OPERATING TEMPERATURE RANGE, case	-55 to $+125^\circ\text{C}$

SPECIFICATIONS

PARAMETER	TEST CONDITIONS ²	PA08			PA08A			UNITS
		MIN	TYP	MAX	MIN	TYP	MAX	
INPUT								
OFFSET VOLTAGE, initial	$T_C = 25^\circ\text{C}$		± 5	± 2		± 25	± 5	mV
OFFSET VOLTAGE, vs. temperature	$T_C = -25^\circ\text{C}$ to $+85^\circ\text{C}$		± 15	± 30		± 5	± 10	$\mu\text{V}/^\circ\text{C}$
OFFSET VOLTAGE, vs. supply	$T_C = 25^\circ\text{C}$		± 5			*	2	$\mu\text{V}/\text{V}$
OFFSET VOLTAGE, vs. time	$T_C = 25^\circ\text{C}$		± 75			*		$\mu\text{V}/\text{kh}$
BIAS CURRENT, initial ³	$T_C = 25^\circ\text{C}$		5	50		3	10	pA
BIAS CURRENT, vs. supply	$T_C = 25^\circ\text{C}$.01			*		pA/V
OFFSET CURRENT, initial ³	$T_C = 25^\circ\text{C}$		± 2.5	± 50		± 1.5	± 10	pA
INPUT IMPEDANCE, DC	$T_C = 25^\circ\text{C}$		10^5			*		M Ω
INPUT CAPACITANCE	$T_C = 25^\circ\text{C}$		4			*		pF
COMMON MODE VOLTAGE RANGE ⁴	$T_C = -25^\circ\text{C}$ to $+85^\circ\text{C}$	$\pm V_S - 10$			*			V
COMMON MODE REJECTION, DC	$T_C = -25^\circ\text{C}$ to $+85^\circ\text{C}$, $V_{CM} = \pm 90\text{V}$		130			*		dB
GAIN								
OPEN LOOP GAIN at 10Hz	$T_C = 25^\circ\text{C}$, $R_L = \infty$		118			*		dB
OPEN LOOP GAIN at 10Hz	$T_C = 25^\circ\text{C}$, $R_L = 1.2\text{K}\Omega$	96	111		*	*		dB
GAIN BANDWIDTH PRODUCT at 1MHz	$T_C = 25^\circ\text{C}$, $R_L = 1.2\text{K}\Omega$		5			*		MHz
POWER BANDWIDTH	$T_C = 25^\circ\text{C}$, $R_L = 1.2\text{K}\Omega$		90			*		kHz
PHASE MARGIN	$T_C = -25$ to $+85^\circ\text{C}$		60			*		°
OUTPUT								
VOLTAGE SWING ⁴	$T_C = 25^\circ\text{C}$, $I_O = 150\text{mA}$	$\pm V_S - 15$	$\pm V_S - 8$		*	*		V
VOLTAGE SWING ⁴	$T_C = -25^\circ\text{C}$ to $+85^\circ\text{C}$, $I_O = \pm 75\text{mA}$	$\pm V_S - 10$	$\pm V_S - 5$		*	*		V
VOLTAGE SWING ⁴	$T_C = -25^\circ\text{C}$ to $+85^\circ\text{C}$, $I_O = \pm 20\text{mA}$	$\pm V_S - 5$	$\pm V_S - 3$		*	*		V
CURRENT, peak	$T_C = 85^\circ\text{C}$	150			*			mA
SLEW RATE	$T_C = 25^\circ\text{C}$		30		20	*		V/ μs
CAPACITIVE LOAD, $A_V = 1$	$T_C = -25$ to $+85^\circ\text{C}$			10			*	nF
CAPACITIVE LOAD, $A_V > 4$	$T_C = -25$ to $+85^\circ\text{C}$			SOA			*	
SETTLING TIME to .1%	$T_C = 25^\circ\text{C}$, $R_L = 1.2\text{K}\Omega$, 2V step		1			*		μs
POWER SUPPLY								
VOLTAGE	$T_C = -55$ to $+125^\circ\text{C}$	± 15	± 100	± 150	*	*	*	V
CURRENT, quiescent	$T_C = 25^\circ\text{C}$		6	8.5		*	*	mA
THERMAL								
RESISTANCE, AC junction to case ⁵	$T_C = -55$ to $+125^\circ\text{C}$, $F > 60\text{Hz}$		4.26			*		$^\circ\text{C}/\text{W}$
RESISTANCE, DC junction to case	$T_C = -55$ to $+125^\circ\text{C}$, $F < 60\text{Hz}$		6.22	8.57		*	*	$^\circ\text{C}/\text{W}$
RESISTANCE, junction to air	$T_C = -55$ to $+125^\circ\text{C}$		30			*		$^\circ\text{C}/\text{W}$
TEMPERATURE RANGE, case	Meets full range specification	-25		85	*		*	$^\circ\text{C}$

NOTES: * The specification of PA08A is identical to the specification for PA08 in applicable column to the left.

1. Long term operation at the maximum junction temperature will result in reduced product life. Derate power dissipation to achieve high MTTF.
2. The power supply voltage specified under typical (TYP) applies unless otherwise noted.
3. Doubles for every 10°C of temperature increase.
4. $+V_S$ and $-V_S$ denote the positive and negative supply rail respectively.
5. Rating applies only if output current alternates between both output transistors at a rate faster than 60Hz.

CAUTION

The internal substrate contains beryllia (BeO). Do not break the seal. If accidentally broken, do not crush, machine, or subject to temperatures in excess of 850°C to avoid generating toxic fumes.

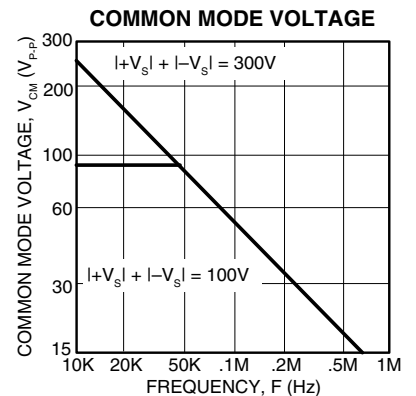
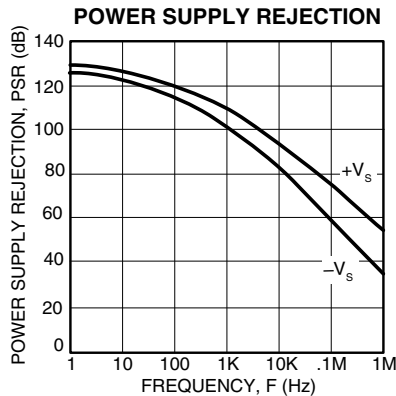
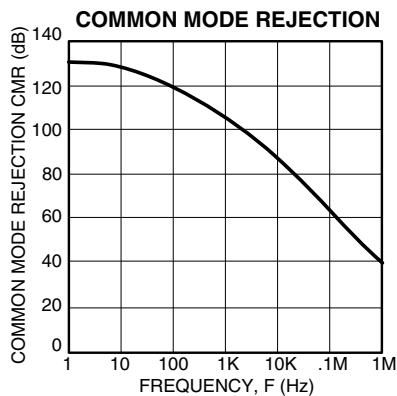
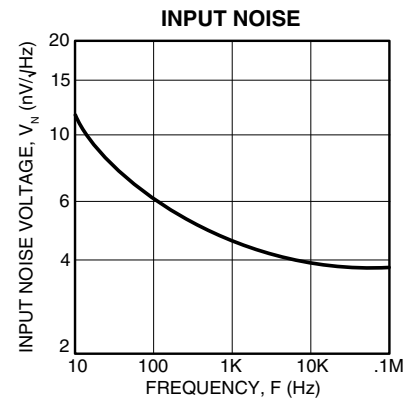
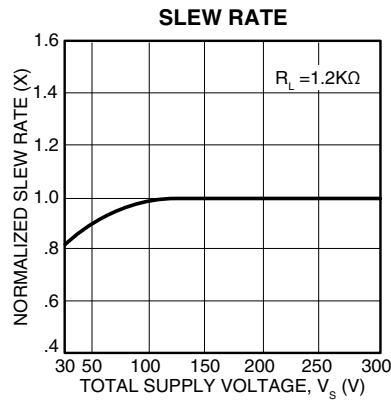
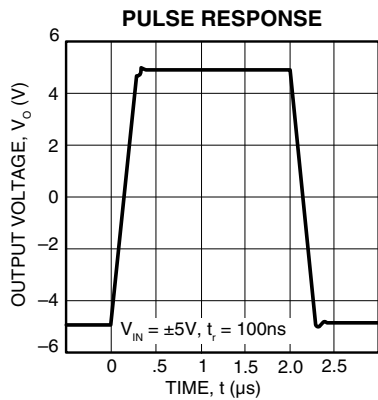
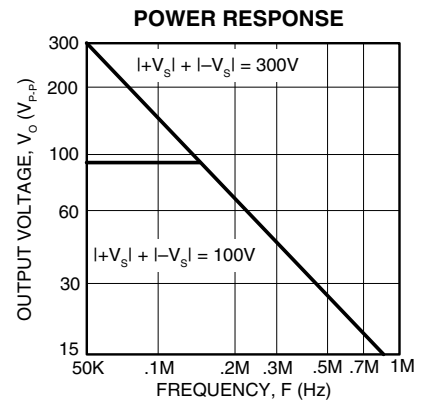
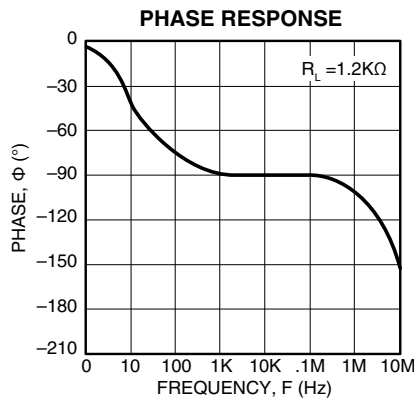
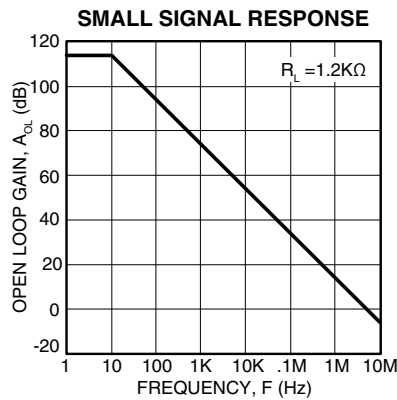
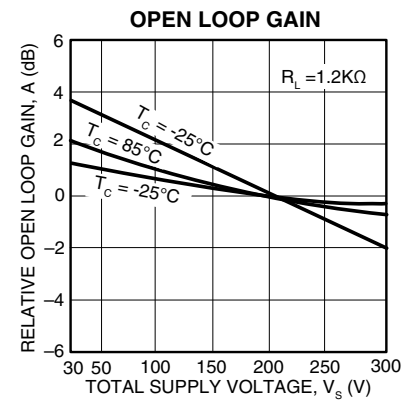
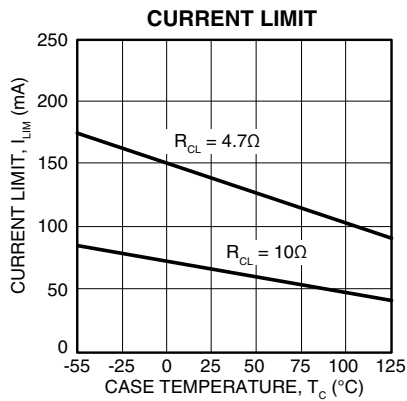
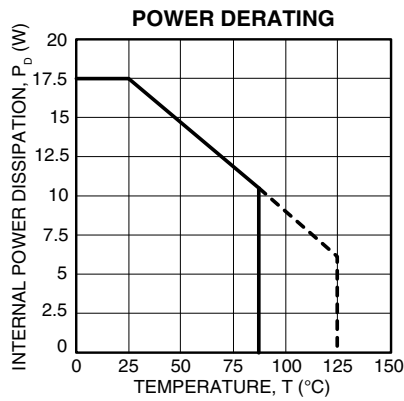

GENERAL

Please read Application Note 1 "General Operating Considerations" which covers stability, supplies, heat sinking, mounting, current limit, SOA interpretation, and specification interpretation. Visit www.apexmicrotech.com for design tools that help automate tasks such as calculations for stability, internal power dissipation, current limit and heat sink selection. The "Application Notes" and "Technical Seminar" sections contain a wealth of information on specific types of applications. Package outlines, heat sinks, mounting hardware and other accessories are located in the "Packages and Accessories" section. Evaluation Kits are available for most Apex product models, consult the "Evaluation Kit" section for details. For the most current version of all Apex product data sheets, visit www.apexmicrotech.com.

SAFE OPERATING AREA (SOA)

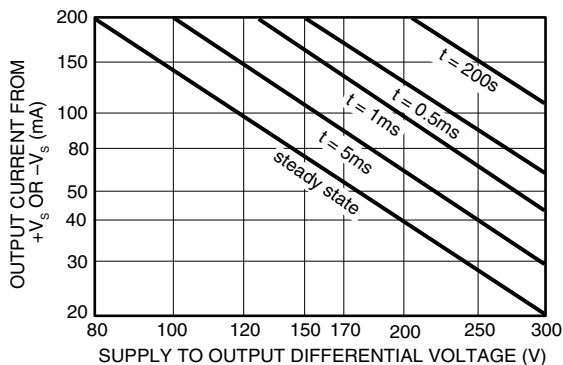

The output stage of most power amplifiers has two distinct limitations:

1. The current handling capability of the transistor geometry and the wire bonds.
2. The second breakdown effect which occurs whenever the simultaneous collector current and collector-emitter voltage exceeds specified limits.

The SOA curves combine the effect of these limits. For a given application, the direction and magnitude of the output current should be calculated or measured and checked against the SOA curves. This is simple for resistive loads but more complex for reactive and EMF generating loads. However, the following guidelines may save extensive analytical efforts.

1. Under transient conditions, the following capacitive and inductive loads are safe with the current limits set to the maximum:

$\pm V_s$	C(MAX)	L(MAX)
150V	.4 μ F	280mH
125V	.9 μ F	380mH
100V	2 μ F	500mH
75V	10 μ F	1200mH
50V	100 μ F	13H

2. The amplifier can handle any EMF generating or reactive load and short circuits to the supply rails or simple shorts to common if the current limits are set as follows:

$\pm V_s$	SHORT TO $\pm V_{sc}$ C, L, OR EMF LOAD	SHORT TO COMMON
150V	20mA	67mA
125V	27mA	90mA
100V	42mA	130mA
75V	67mA	200mA
50V	130mA	200mA

These simplified limits may be exceeded with further analysis using the operating conditions for a specific application.

3. The output stage is protected against transient flyback. However, for protection against sustained, high energy flyback, external fast-recovery diodes should be used.

INDUCTIVE LOADS

Two external diodes as shown in Figure 1, are required to protect these amplifiers from flyback (kickback) pulses exceeding the supply voltages of the amplifier when driving inductive loads. For component selection, these external diodes must be very quick, such as ultra fast recovery diodes with no more than 200 nanoseconds of reverse recovery time. The diode will turn on to divert the flyback energy into the supply rails thus protecting the output transistors from destruction due to reverse bias.

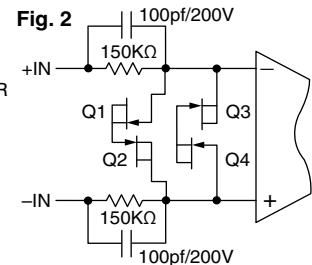
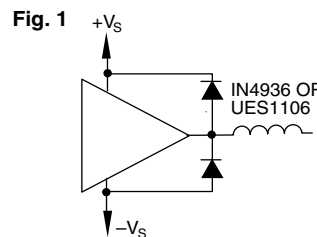

PROTECTION, INDUCTIVE LOAD PROTECTION, OVERVOLTAGE

A note of caution about the supply. The energy of the flyback pulse must be absorbed by the power supply. As a result, a transient will be superimposed on the supply voltage, the magnitude of the transient being a function of its transient impedance and current sinking capability. If the supply voltage plus transient exceeds the maximum supply rating or if the AC impedance of the supply is unknown, it is best to clamp the output and the supply with a zener diode to absorb the transient.

INPUT PROTECTION

The input is protected against common mode voltages up to the supply rails and differential voltages up to $\pm 50V$. Increased protection against differential input voltages can be obtained by adding 2 resistors, 2 capacitors and 4 diode connected FETs as shown in Figure 2.

CURRENT LIMITING

Proper operation requires the use of two current limit resistors, connected as shown in the external connection diagram. The minimum value for R_{CL} is 3.24 Ω . However, for optimum reliability it should be set as high as possible. Refer to the "General Operating Considerations" section of the handbook for current limit adjust details.